

A
422

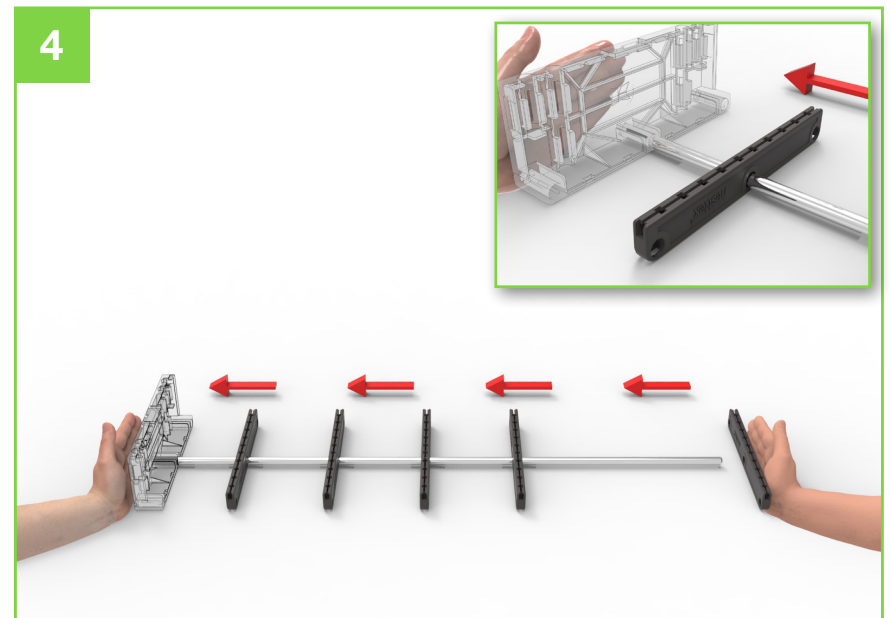

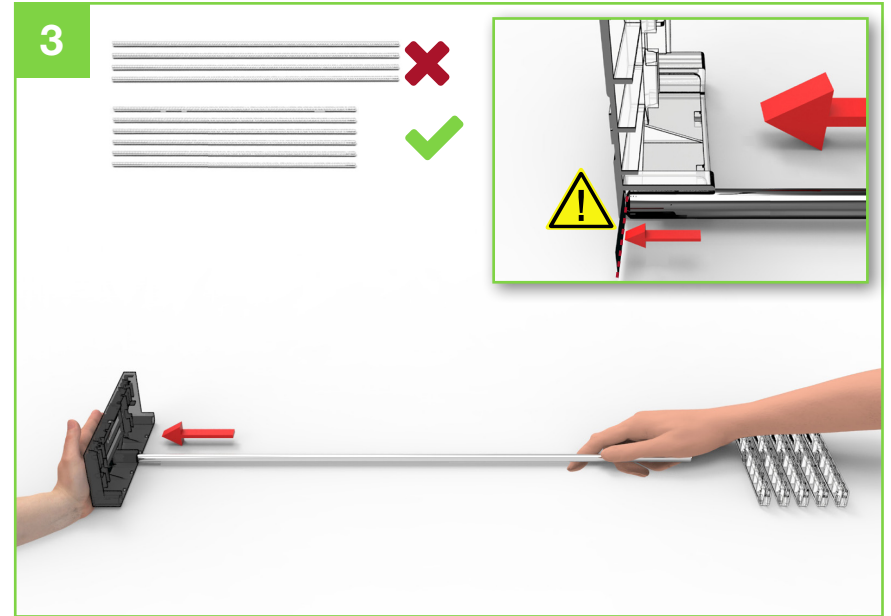

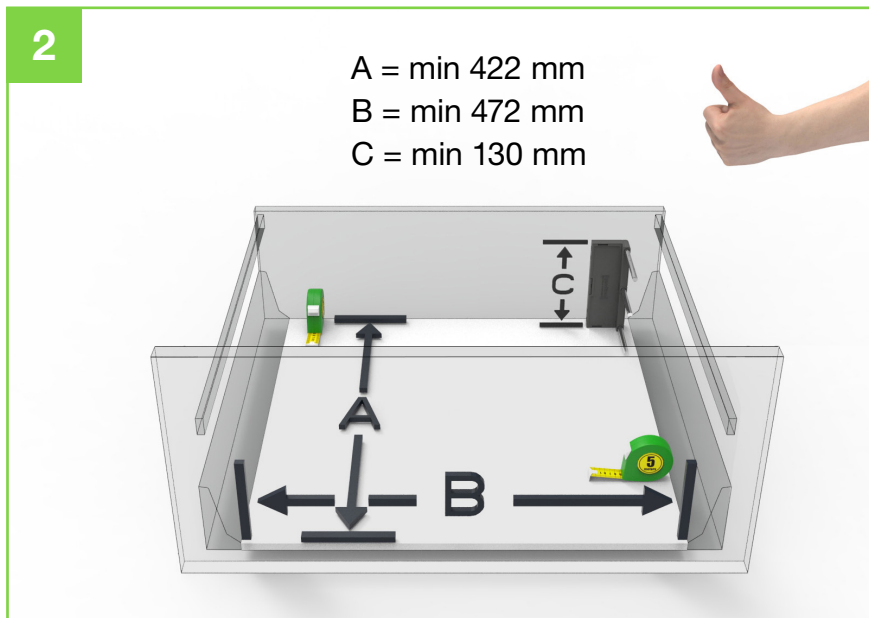
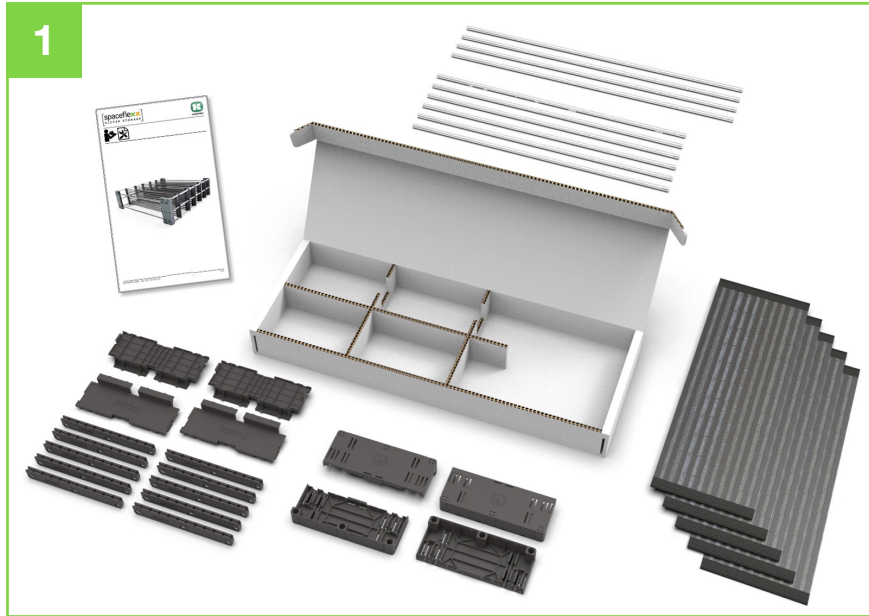
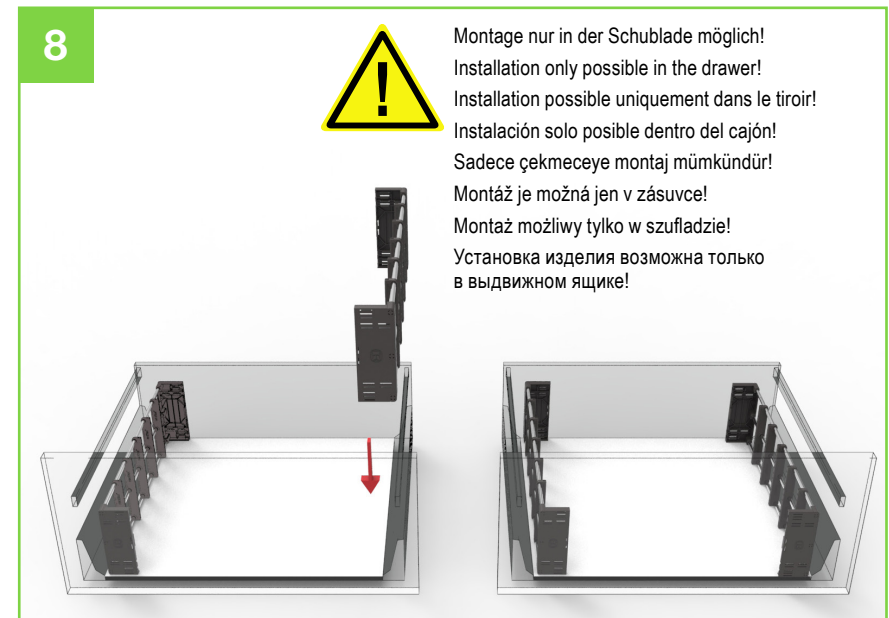
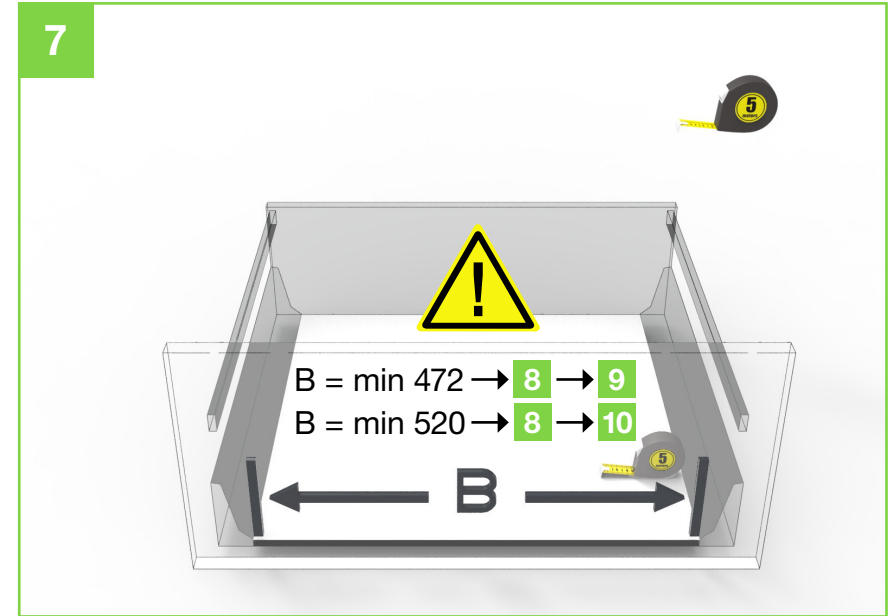
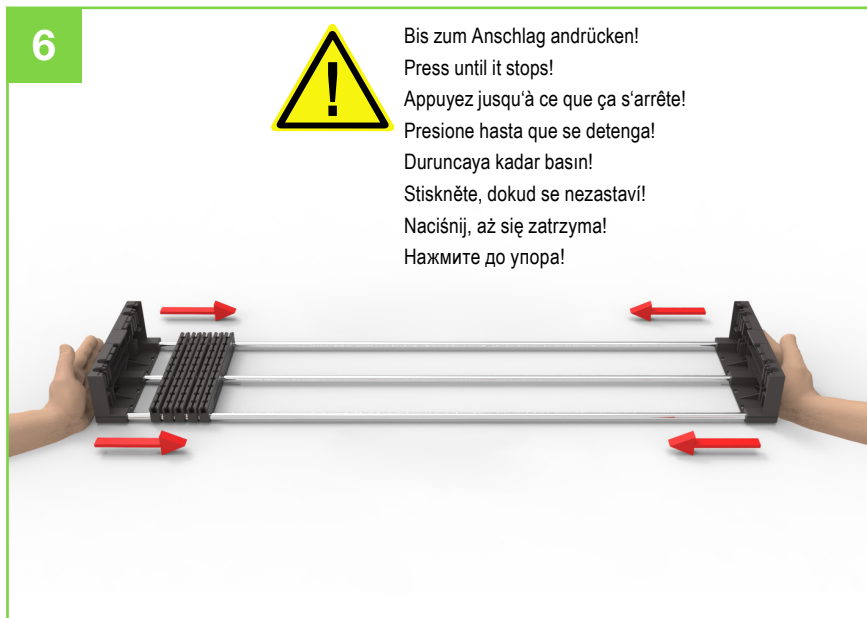
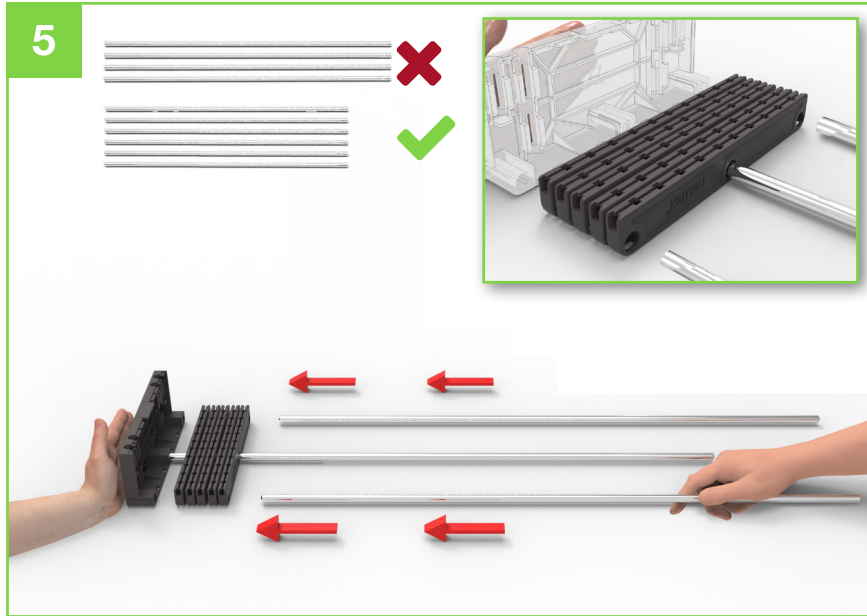
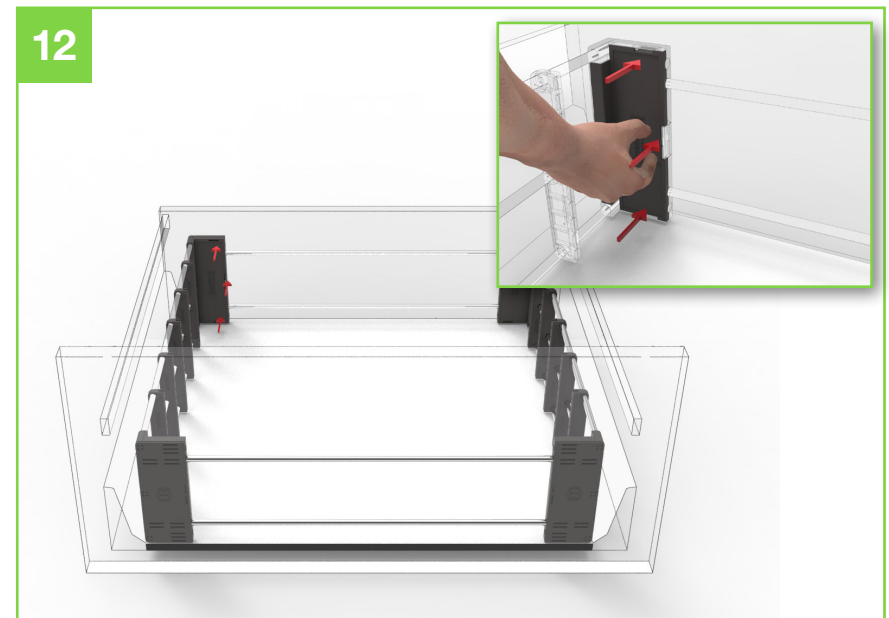
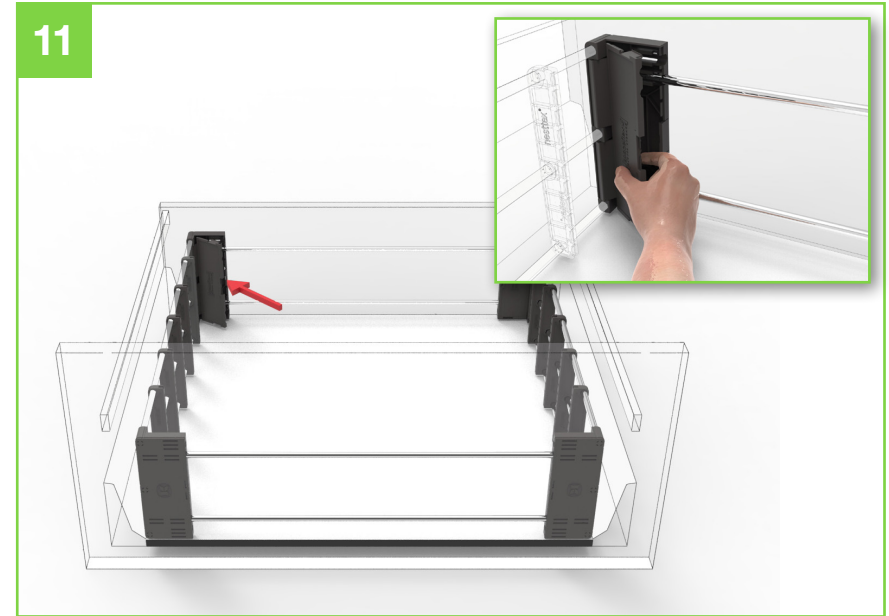
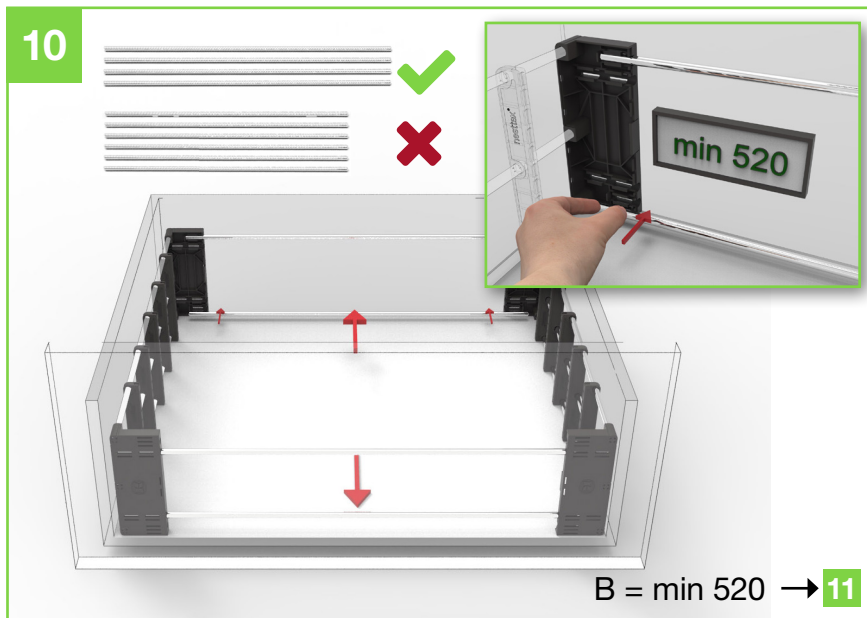
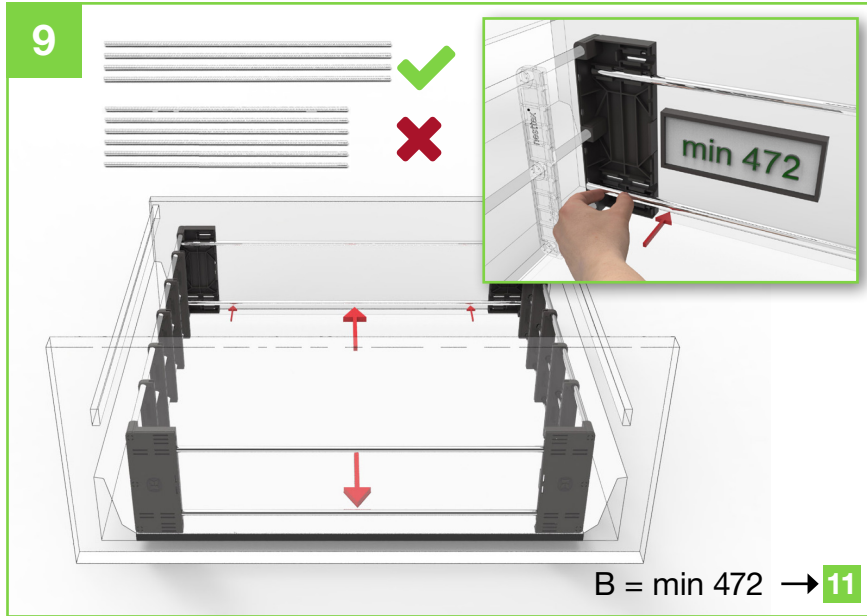

13

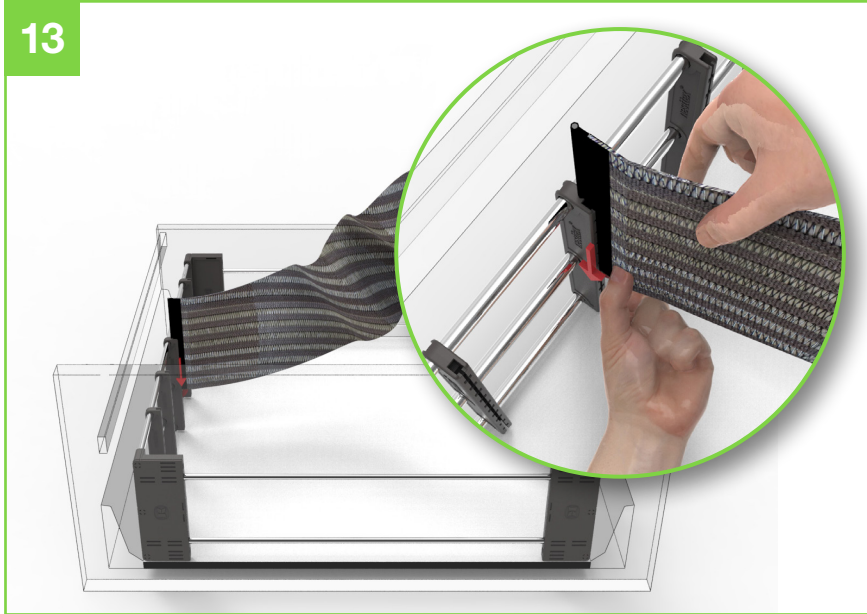

14

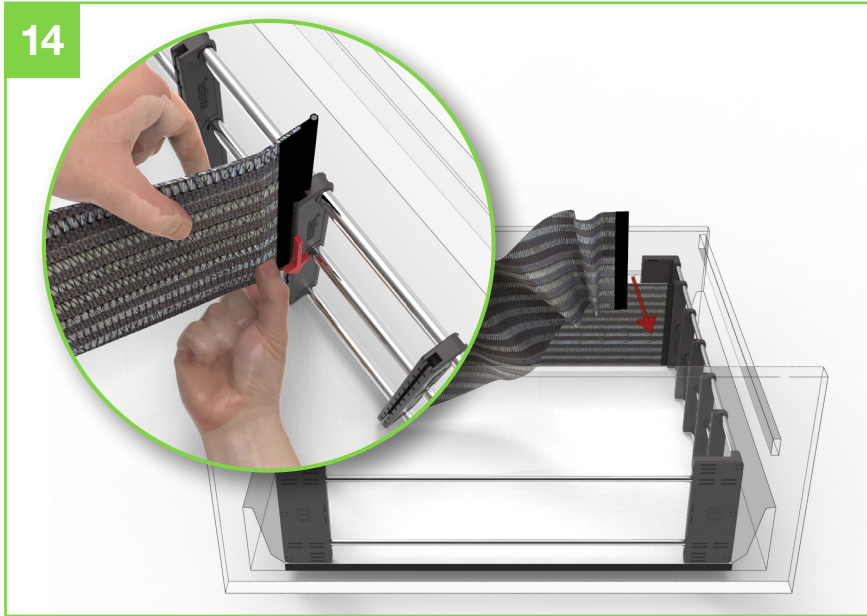



Vor Entnahme aus der Schublade das Produkt wie hier beschrieben **demontieren!**

Before removing from the drawer the product **dismantle** as described here!

Avant de retirer du tiroir le produit **démontez** comme décrit ici!

¡**Nunca** extraer el producto sin haberlo desmontado previamente como se muestra abajo.

Çekmeden **çıkarmadan önce** ürünü burada açıklanan şekilde sökün!

Před vyjmutím ze zásuvky demontujte výrobek, jak je popsáno zde!

Przed wyjęciem z szuflady należy zdemontować produkt w opisany tutaj sposób!

Перед извлечением изделия из ящика следует его разобрать, как описано здесь!

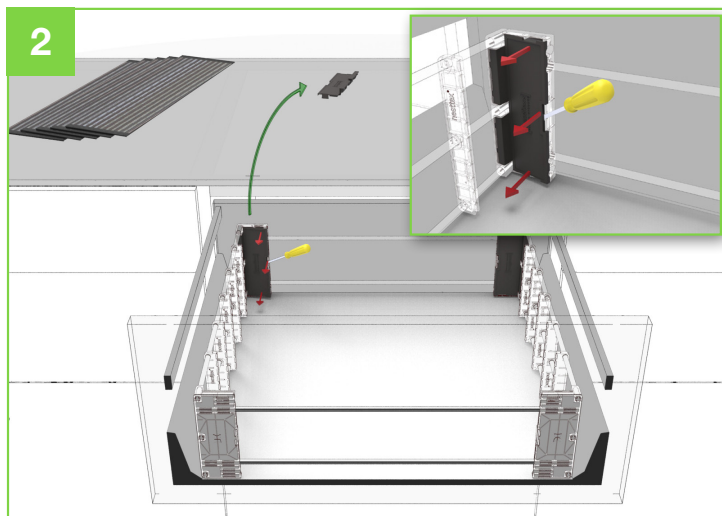
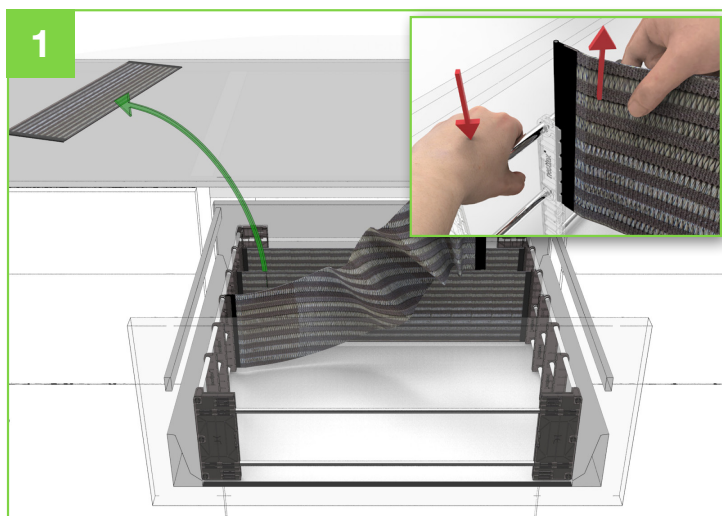

Vor Entnahme aus der Schublade das Produkt wie hier beschrieben **demontieren!**

Before removing from the drawer the product **dismantle** as described here!

Avant de retirer du tiroir le produit **démontez** comme décrit ici!

¡**Nunca** extraer el producto sin haberlo desmontado previamente como se muestra abajo.

Çekmeden **çıkarmadan önce** ürünü burada açıklanan şekilde sökün!

Před vyjmutím ze zásuvky demontujte výrobek, jak je popsáno zde!

Przed wyjęciem z szuflady należy zdemontować produkt w opisany tutaj sposób!

Перед извлечением изделия из ящика следует его разобрать, как описано здесь!

